

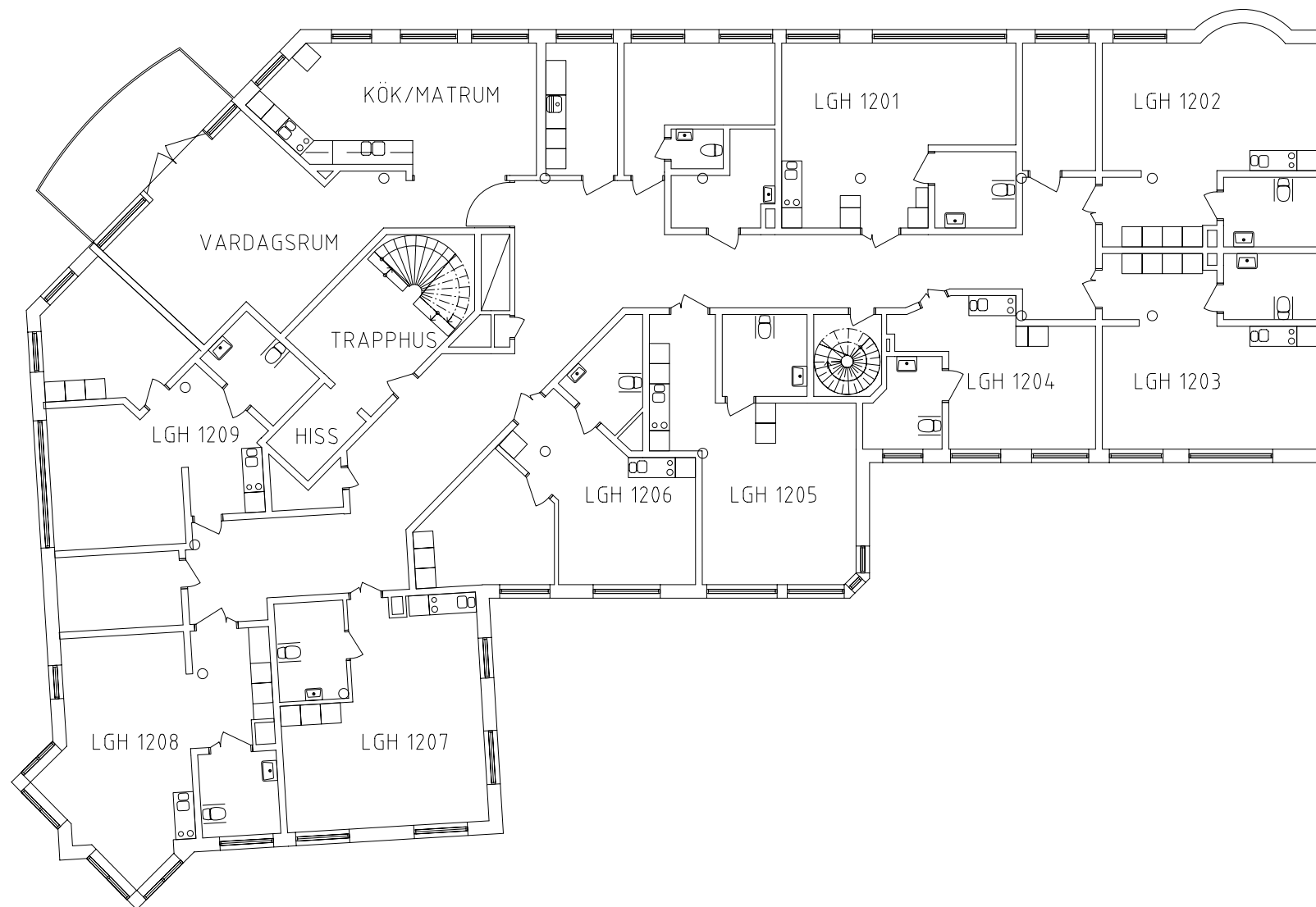

Backagården

Avdelning: plan 3

NORR

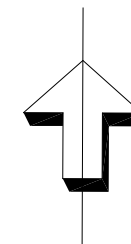



Backagården

Avdelning: plan 3

Lägenhet: 1201

NORR

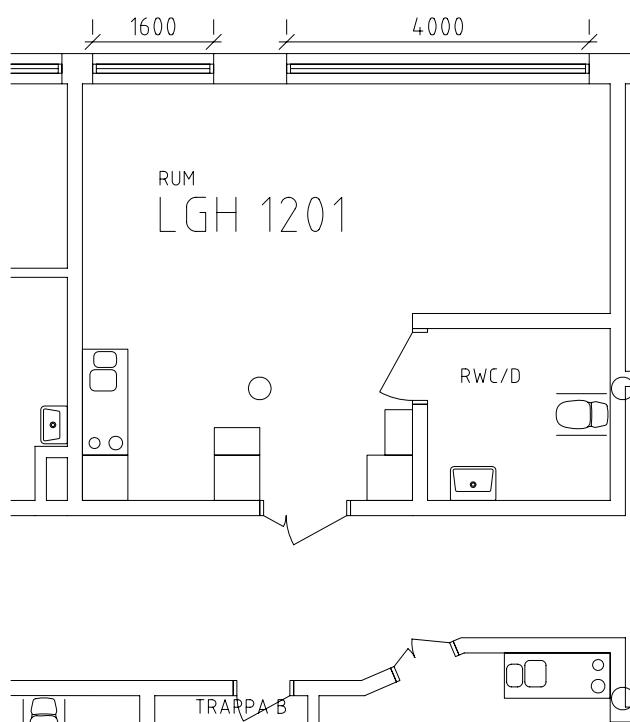
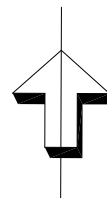

Skala: 1:100



Backagården

Avdelning: plan 3

Lägenhet: 1202

NORR

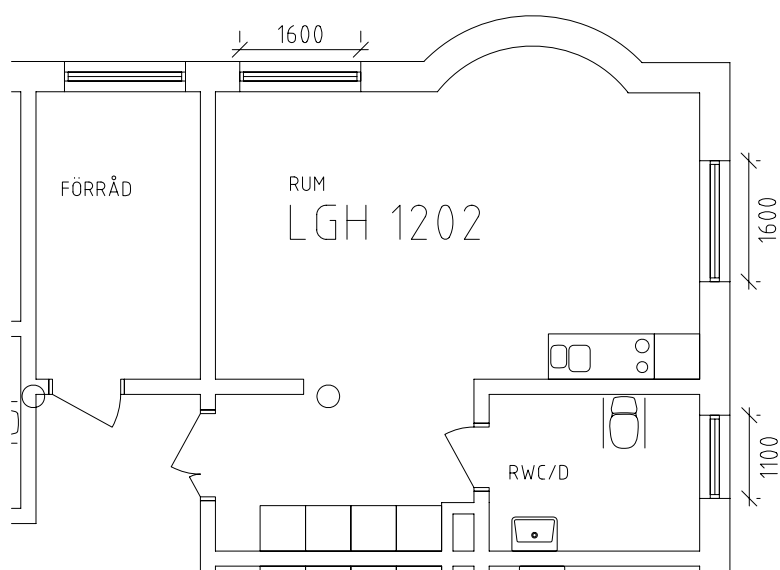
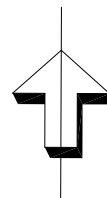

Skala: 1:100



Backagården

Avdelning: plan 3

Lägenhet: 1203

NORR

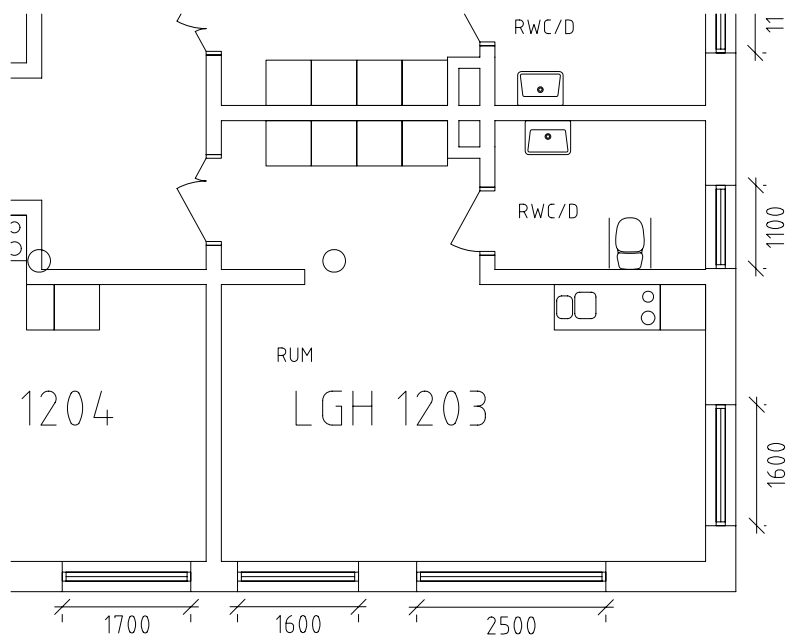
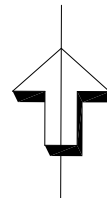

Skala: 1:100



Backagården

Avdelning: plan 3

Lägenhet: 1204

NORR

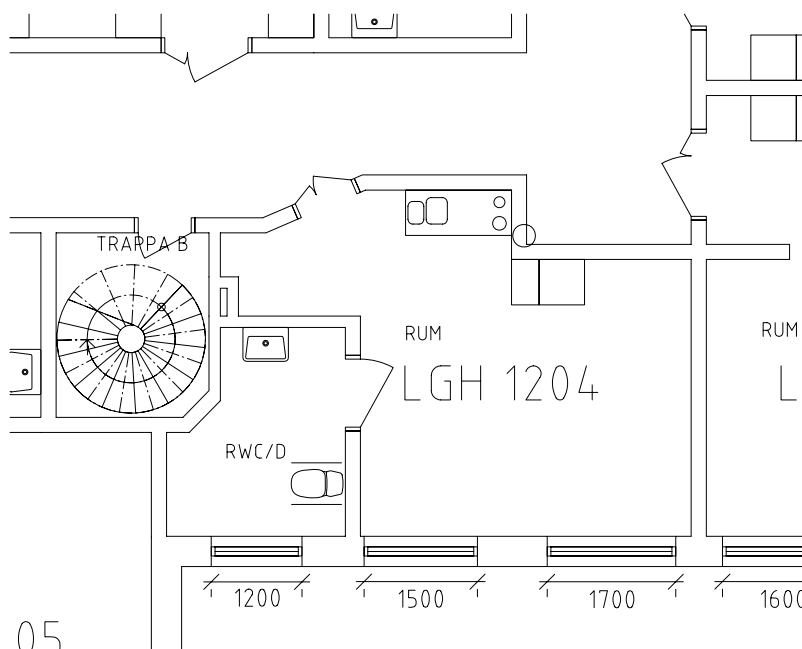
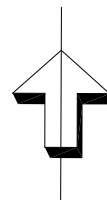

Skala: 1:100



Backagården

Avdelning: plan 3

Lägenhet: 1205

NORR

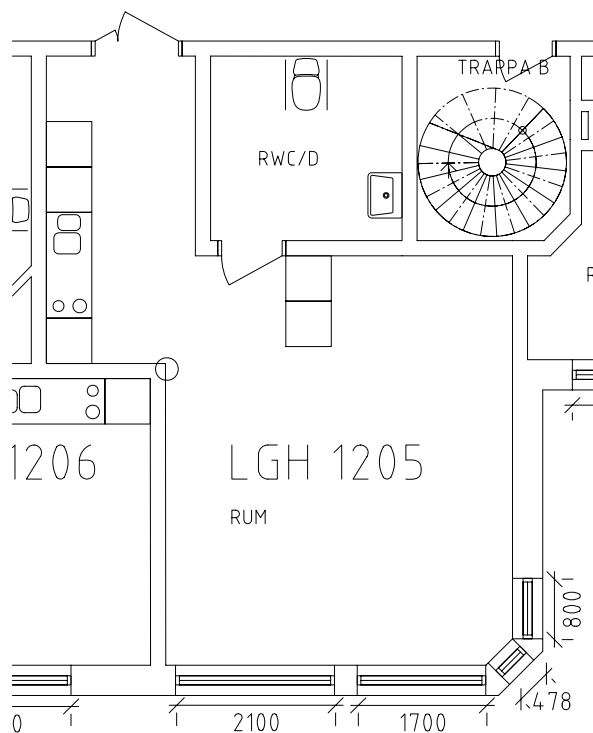
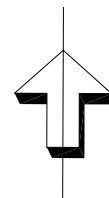

Skala: 1:100



Backagården

Avdelning: plan 3

Lägenhet: 1206

NORR

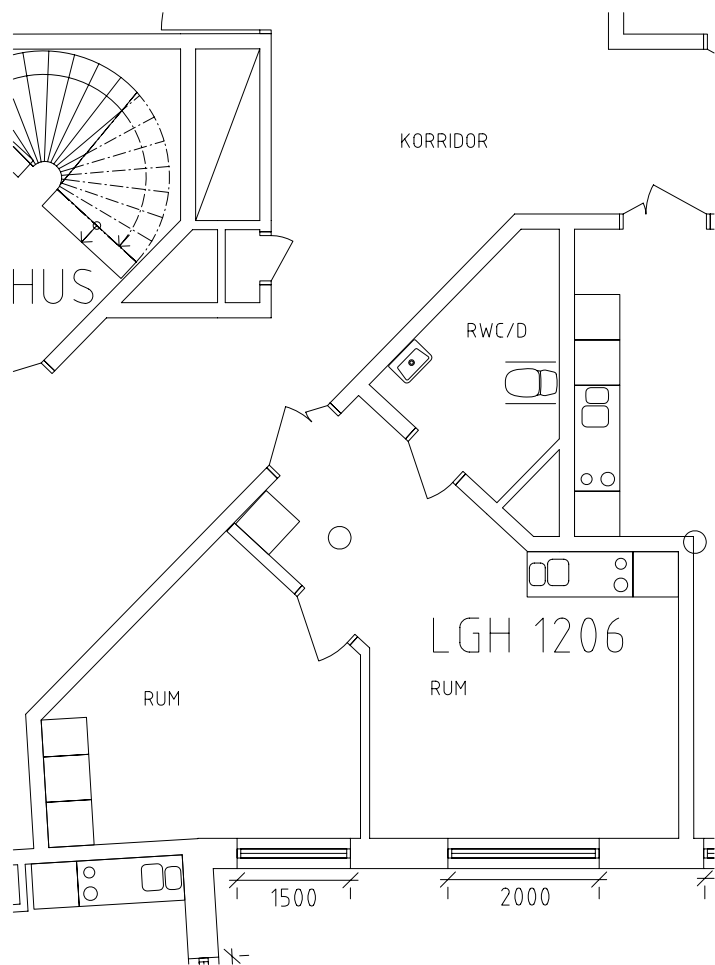
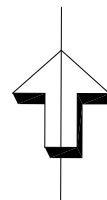

Skala: 1:100



Backagården

Avdelning: plan 3

Lägenhet: 1208

NORR

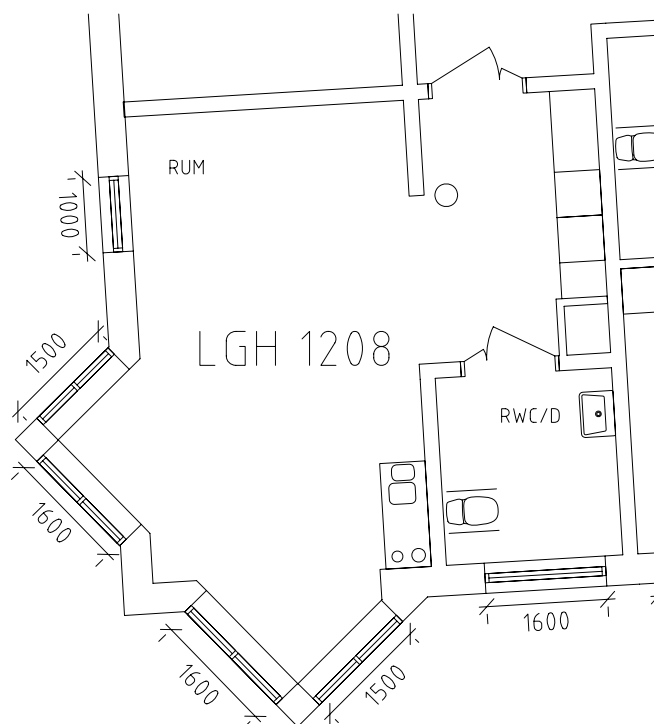
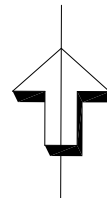

Skala: 1:100



Backagården

Avdelning: plan 3

Lägenhet: 1209

NORR

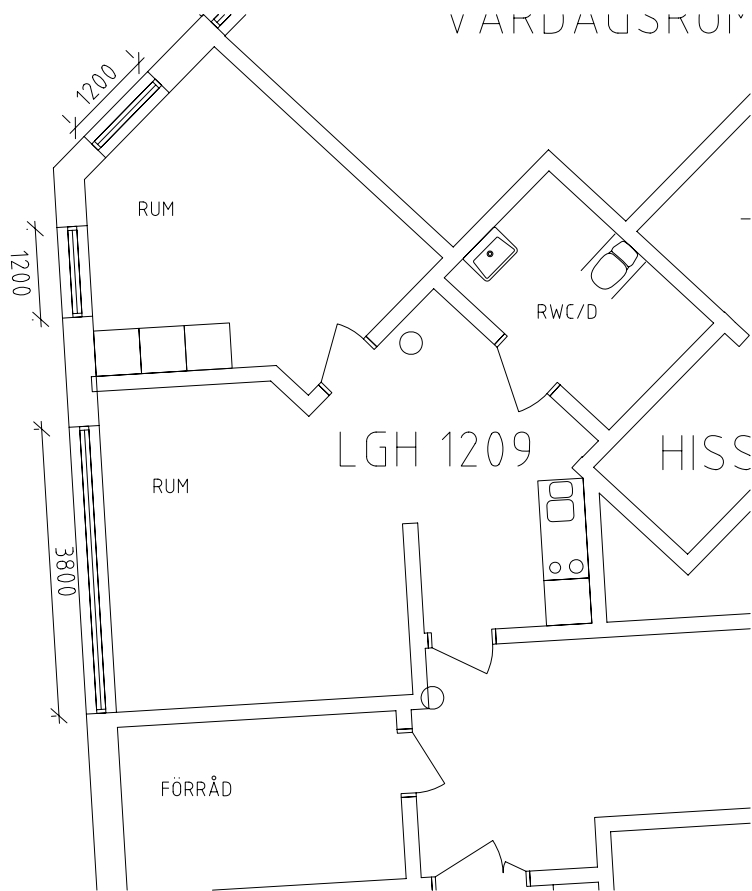
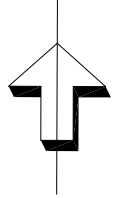

Skala: 1:100



ÖREBRO

Backagården

Orientering plan 1

NORR

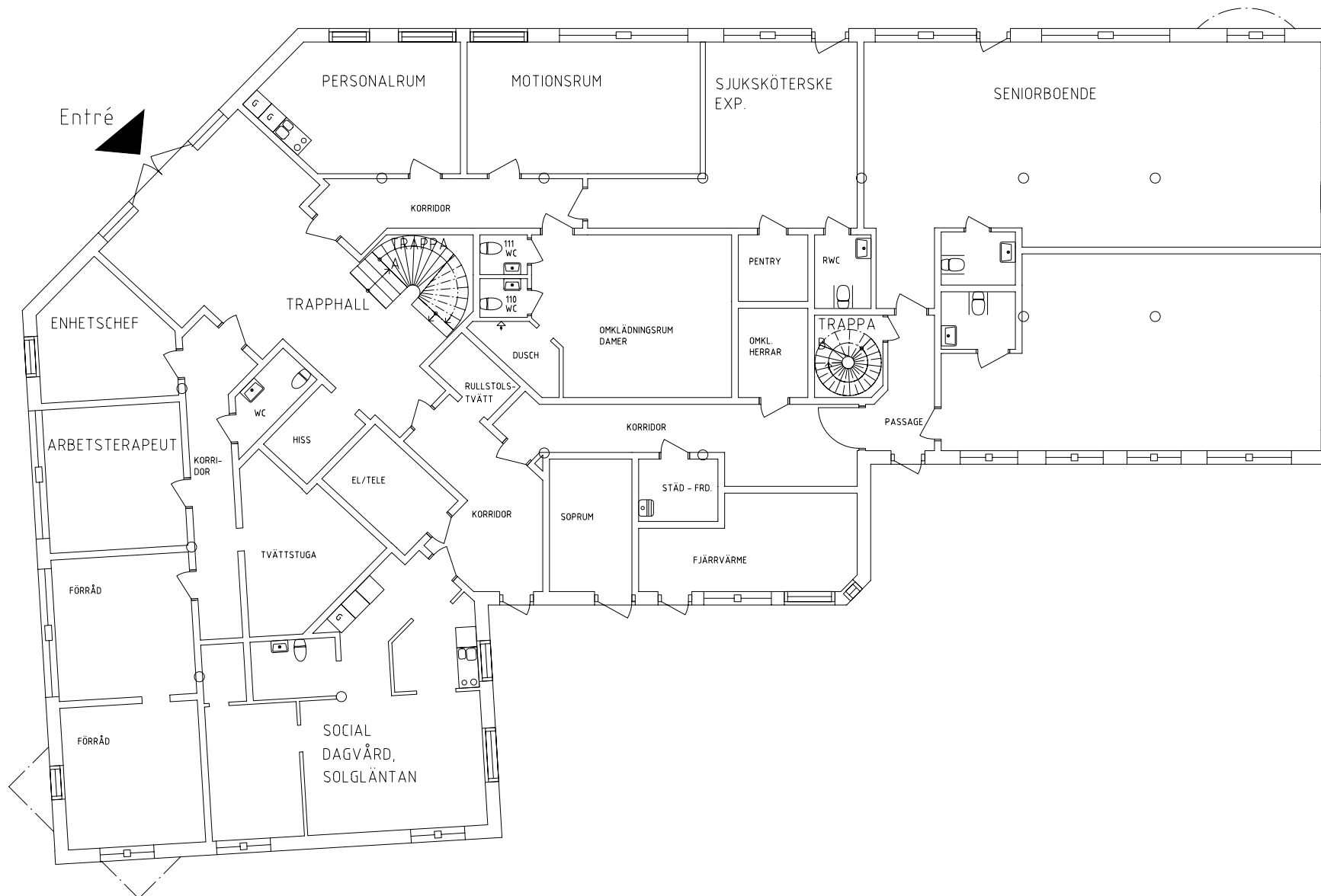
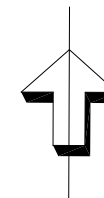



Backagården

Gemensamma utrymmen

NORR

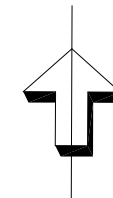

Entré, arbetsterapeut, motionsrum samt sjuksköterske exp.
i plan 1 entréplan.

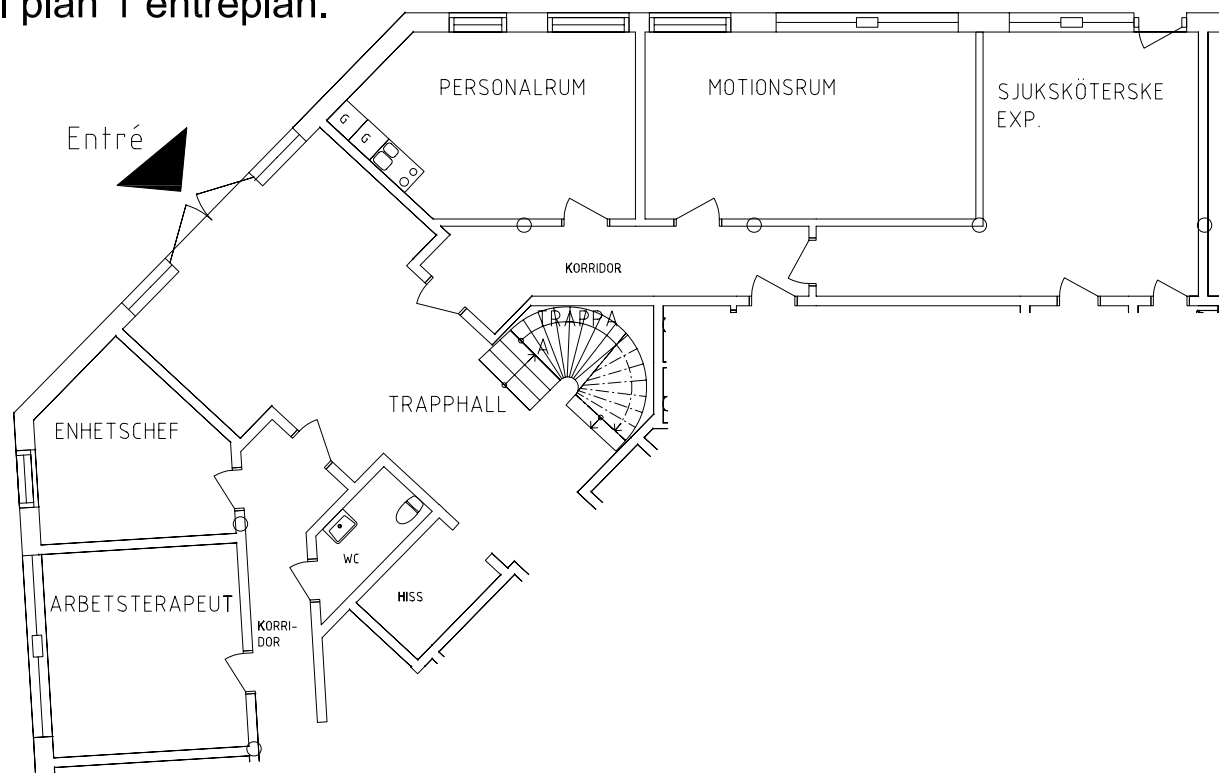



Backagården

Gemensamma utrymmen

NORR

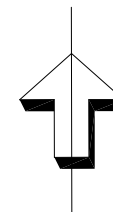

Övernattningslägenhet samt
lägenhetsförråd på plan 6

